

MATHYS 
European Orthopaedics

EXCLUSIVE DISTRIBUTOR IN BRAZIL

ATTIS
MEDICAL

For healthcare professional use only. This and the following illustrated images are not represent a connection between the use of the medical device described, nor its performance.

Preservation in motion

Affinis Inverse
Inverse shoulder prosthesis



PROVEN

EVOLUTION VERSUS REVOLUTION

The foundation for the development of Affinis Inverse was laid by analysing data on complication and revision rates from registries and multicentric studies. In regular literature searches, the Grammont system shows a lower revision rate in the medium term (9.75 % after > 5 years) than all other systems do (10.1 % after > 2 years).

This is the basis on which the Affinis Inverse system is built. Mathys wanted to retain the positive aspects and implement improvements in an evolutionary manner. What works should not be radically changed but rather systematically improved.

In this context, the following four clinical challenges for optimisation were identified:



X-Ray by courtesy of Prof. U. Irlenbusch

EVOLUTION VERSUS REVOLUTION

1. The polyethylene inlay on the humeral side can lead to PE abrasion on the scapula neck. Progressive osteolyses were observed already within the first one to two years in case of such mechanical notching. According to a 2017 publication¹, an inferior notching rate of 10.1 % after at least two years was observed also in a modern system with lateralised onlay stem, 145° inclination and PE inlay.
2. The systematic implant-to-implant contact of the inlay with the cortical screw placed as far inferiorly as possible in the subchondral bone of the scapula neck results in coarse PE abrasion up to metallosis and screw fractures. Alternatively, the inferior screw is inserted in parallel orientation to the peg of the metaglene and thus in many cases in the cancellous bone, whereby it loses its traction and fixation function, and implants loosen.
3. Modular stems resulted in an increased risk of disconnections.
4. According to Molé et al.², an infection rate four times as high as with anatomical shoulder prostheses was observed in the case of the Grammont system with its large number of individual components and cavities in the implant. Combination of multiple individual components furthermore entails a higher risk of disconnections.

Under the premise of «evolution versus revolution», these four main challenges had to be addressed by innovative solutions with the Affinis Inverse prosthesis.



**10 YEARS
CLINICAL
EXPERIENCE**

More than ten years of clinical experience as well as good medium-term clinical³ and radiological results prove the success of Affinis Inverse and stand for an evolutionary and proven inverse shoulder prosthesis.

EVOLUTIONARY DESIGN

GLENOSPHERE



Metaglene DP – Standard solution for initial treatments

In the Metaglene DP (Double Peg), inlay screw notching was eliminated by metaglene optimisation to a two-peg design without an inferior screw. Thanks to the two-peg design, the two anterior/posterior screws can be placed more centrally and also in a converging orientation, thus enabling deep anchoring in the anterior as well as in the posterior bone stock. In this case, after being screwed in, the superior screw is finally locked at a fixed angle with the base plate by means of a locking cap. All the screws are given a certain amount of freedom during placement so as to allow optimal anchoring in the cortical bone.

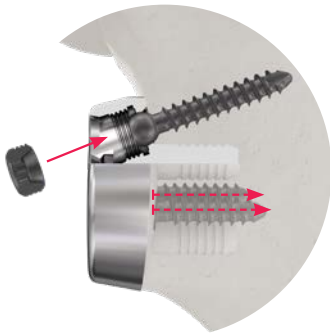

An increased impingement-free range of motion is achieved by a systematic glenosphere overhang. The by-design eccentricity of the metaglene, together with the placement on the inferior edge of the glenoid, reduces the risk of notching.

A snap-in mechanism ensures a stable connection between metaglene and glenosphere. The snap-in fixation of the glenosphere is secured by means of a fixation screw, in order to prevent loosening of the connection between the components. Deliberately, a compact design with only two components (metaglene and glenosphere) was chosen. By reducing the number of cavities and individual parts, the risk of infection is intended to be minimised. The rate of infection was reduced from 4.0% with earlier systems⁴ to 0.7% with the Affinis Inverse prosthesis⁵.

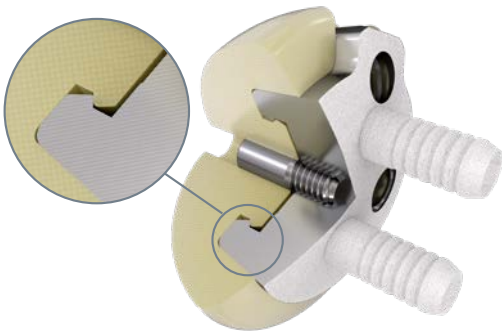

In the development of the Affinis Inverse metaglene, care was furthermore taken to avoid lateralising the centre of rotation of the glenoid components, and instead to place it directly on the bone-implant level. Tensions in the joint and shear forces which can negatively affect the bone-implant connection can thereby be reduced.

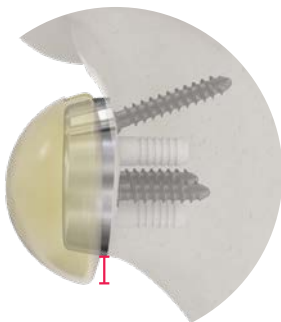

EVOLUTIONARY DESIGN

GLENOSPHERE

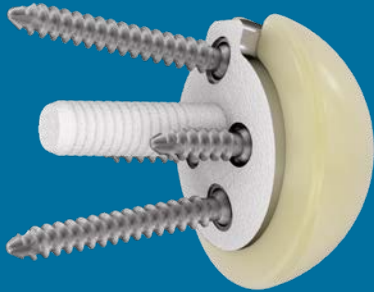

Metaglène CP – for larger defects, deformities, or revision cases

For more options in the treatment of larger defects or deformities, or in revision cases, the Metaglène CP (Central Peg) is ideal. A slightly stronger central press-fit peg in four lengths allows good primary stability even in difficult cases. Even where bone augmentation must be performed, the Metaglène CP is a suitable solution. For stable anchoring, in addition to the central peg the Metaglène CP has the same screw design as the Metaglène DP has. However, in the Metaglène CP, four compression screws are used. Moreover, in the superior as well as in the inferior position, these can eventually be locked after insertion at a fixed angle, using a locking cap.



One size of Metaglène DP made of titanium (Ti6Al4V, TiCP + CaP coated)



Three sizes of glenospheres made of vitamys or UHMWPE

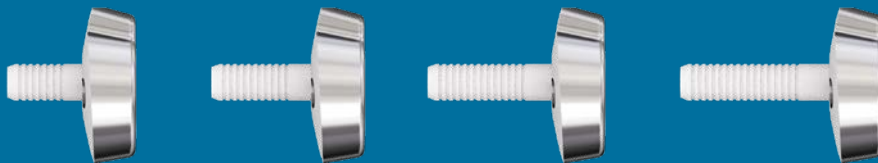

Four sizes of Metaglène CP made of titanium (Ti6Al4V, TiCP + CaP coated)



EVOLUTIONARY

EVOLUTIONARY DESIGN

STEM

The Affinis Inverse prosthesis convinces also on the humeral side with its evolutionary design with monolithic press-fit stems. In the same manner as for the glenosphere, the risk of infection was to be minimised by reducing the number of individual parts in the stem. ⁶ Connection of multiple individual components additionally entails a higher risk of disconnections. ⁷

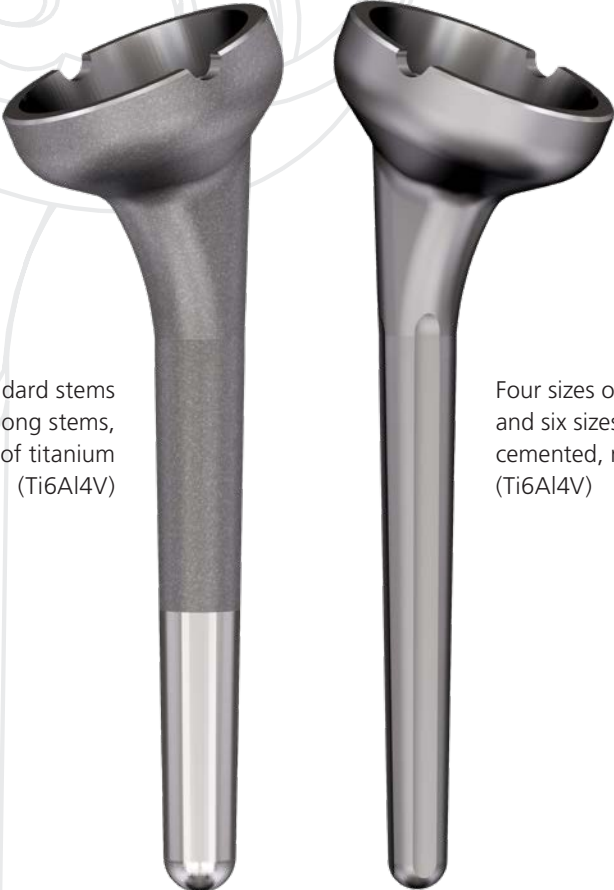

Seven sizes of standard stems
and five sizes of long stems,
uncemented, made of titanium
(Ti6Al4V)

Four sizes of standard stems
and six sizes of long stems,
cemented, made of titanium
(Ti6Al4V)

INVERSE



INVERSE SOLUTION

INLAY

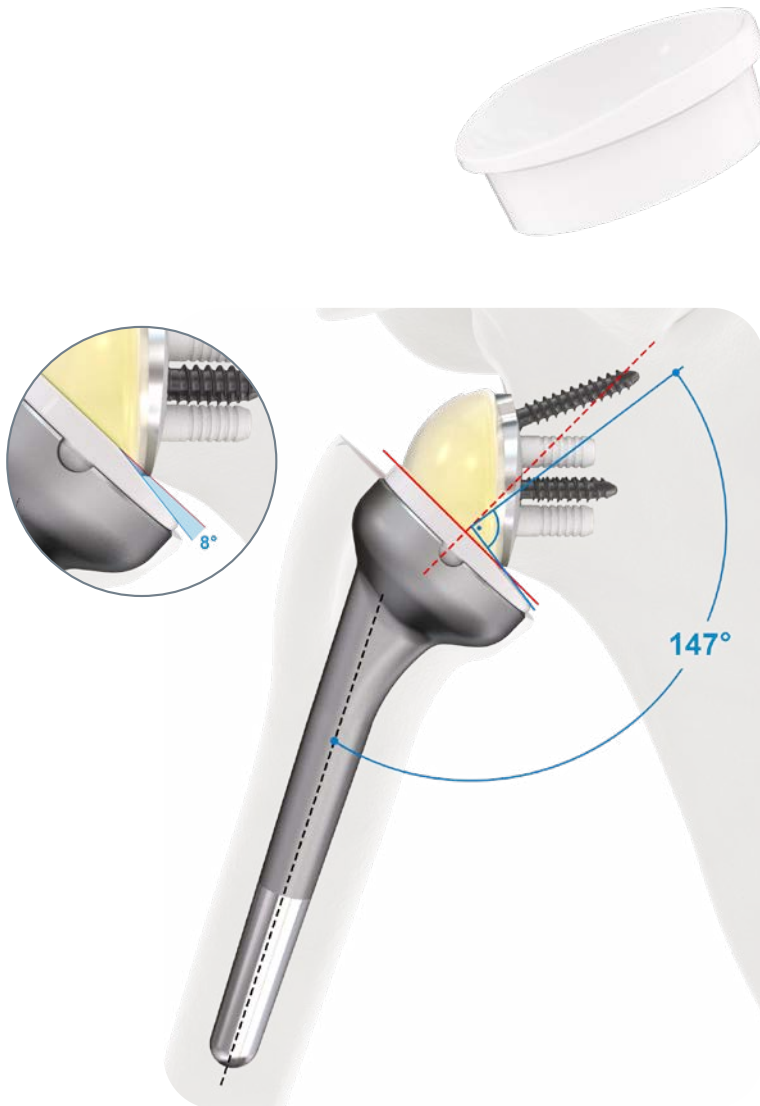

Inversion of the materials in the tribological pairing to a hard inlay of ceramic or metal on the humeral side eliminates polyethylene abrasion on the scapula neck and surrounding structures.⁸ This results in a reduced risk of polyethylene-induced disorders such as osteolyses.⁹⁻¹²

Due to the medial inlay chamfer of 8°, the frequently discussed mean inclination was transferred to the inlay. The original stem inclination of 155° is thus reduced by 8°. This results in an effective mean inclination of 147°, allowing increased adduction without mechanical notching in the neutral position of the humerus and generally a higher range of motion.



Nine inlay variants, three sizes each in three heights, made of ceramic ($ZrO_2-Al_2O_3$) or metal (CoCrMo)

PROGRESSIVE MATERIALS

The Affinis Inverse shoulder system is defined by an evolutionary implant design as well as by use of progressive materials.

These are vitamys, a highly crosslinked polyethylene enriched with vitamin E, for the glenosphere. The benefits of vitamys are obvious: The good mechanical strength allows long-term mechanical performance of the material. The high wear resistance reduces wear and thus the risk of osteolyses.¹⁰⁻¹² The addition of vitamin E furthermore ensures resistance to oxidation and thus high resistance to ageing as well.¹³

Mathys uses high-quality ceramics for the inlay. Low wear rates, high strength and toughness, good wettability as well as biologically inert behaviour^{9,13,14} argue for this material. These advantages make the ceramics a treatment option not only for young and active patients.

For the Affinis Inverse stems and the metaglene, the titanium alloy Ti6Al4V is used, which has proven its worth in medical technology for many years. The quality of the alloy is shown by a controlled homogeneous structure and the high strength of the material, and it permits nickel-free anchoring in the bone.



Titanium



vitamys



Ceramics



Titanium

REDUCED WEAR



The ceramys ceramic inlay as well as the vitamys (PE) glenosphere of the Affinis Inverse prosthesis show significantly lower wear in simulator testing than UHMWPE (PE) or cobalt-chromium (CoCr) components do. The wear reduction of the optimum coupling of vitamys/ceramys compared to the coupling of CoCr/UHMWPE is 82 %.¹⁵

Affinis Inverse

Reduction of wear¹⁵

Wear reduction in % of the Affinis Inverse sliding couplings

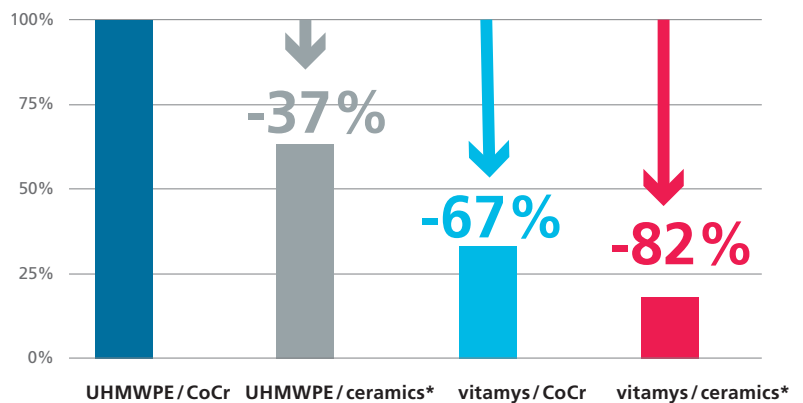

* ceramys

REDUCED RISK OF ALLERGY



Allergic reactions to metal ions in joint replacement are an issue that concerns patients and physicians. Ceramics, titanium and PE/vitamys provide a solution for patients with hypersensitivity to nickel, cobalt, chromium and molybdenum ions. The Affinis Inverse system thus offers implants that are directly available as a standard solution for cases of hypersensitivity.

CLEVER



SMART INSTRUMENTATION

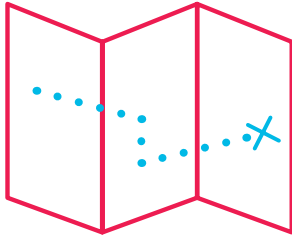

The Affinis Inverse system offers smart instrumentation, and as a result, it allows convenient operation with simple and logical workflows for efficient installation of the prosthesis. In addition, all surgical steps are instrumentally guided. Free-hand manipulations are avoided, hence reproducible results can be achieved.

The instruments are arranged in a straightforward tray concept that ensures and simplifies overview of the entire instrumentation at all times.

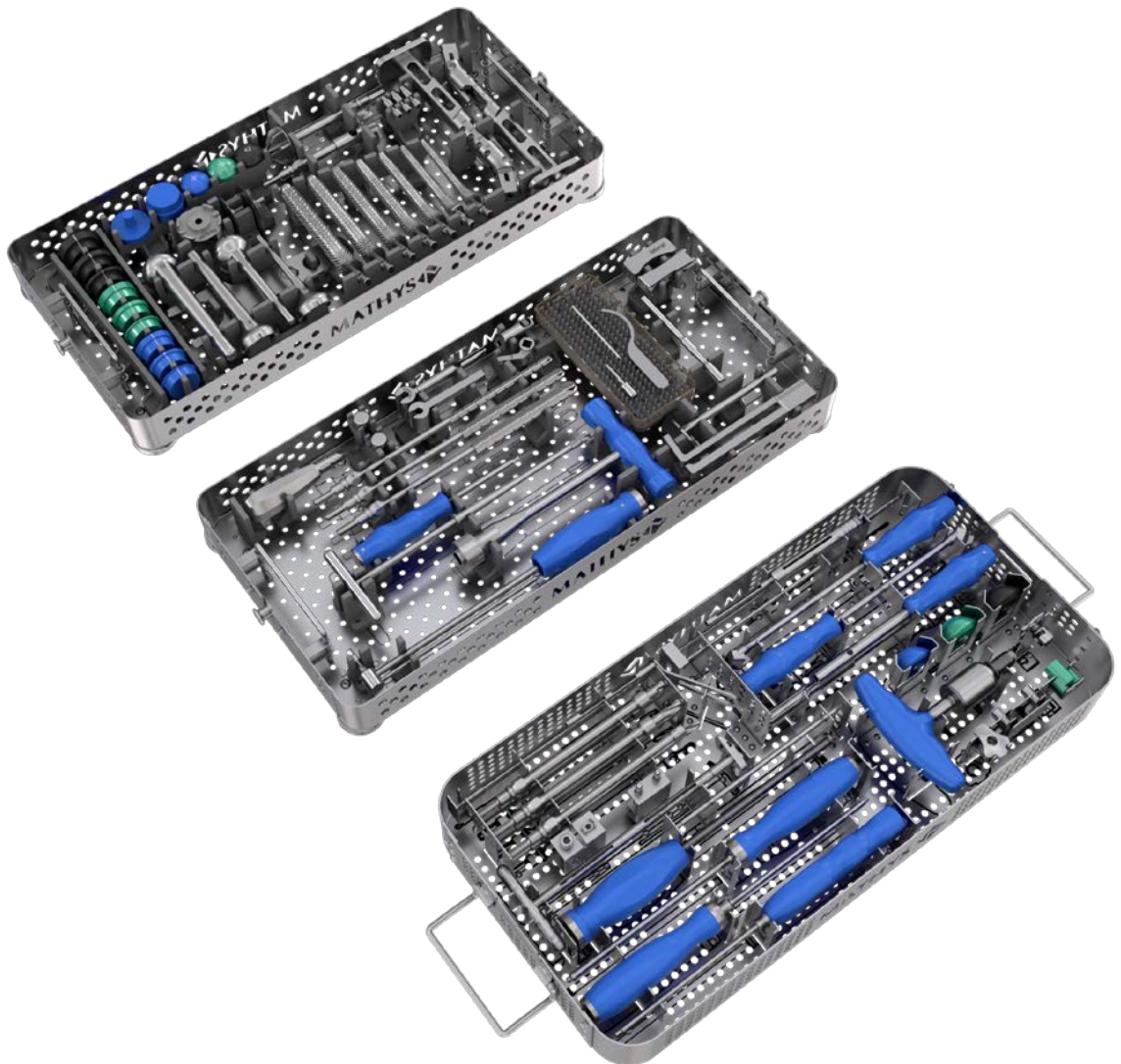

AFFINIS INVERSE SHOULDER PROSTHESIS

Evolutionary

Inlay screw notching was eliminated by metaglens optimisation to a two-peg design without an inferior screw. An increased impingement-free range of motion is achieved by a systematic glenosphere overhang and chamfered inlays – with an effective humeral stem inclination of 147° .¹⁶

Inverse

With an inversion of the materials in the tribological pairing, polyethylene abrasion at the scapular neck and the surrounding structures is eliminated.⁸ This results in a reduced risk of polyethylene-induced diseases.^{9–12}

Proven

Proven primary procedure with more than 10 years of clinical experience and strong clinical evidence.^{3, 17}

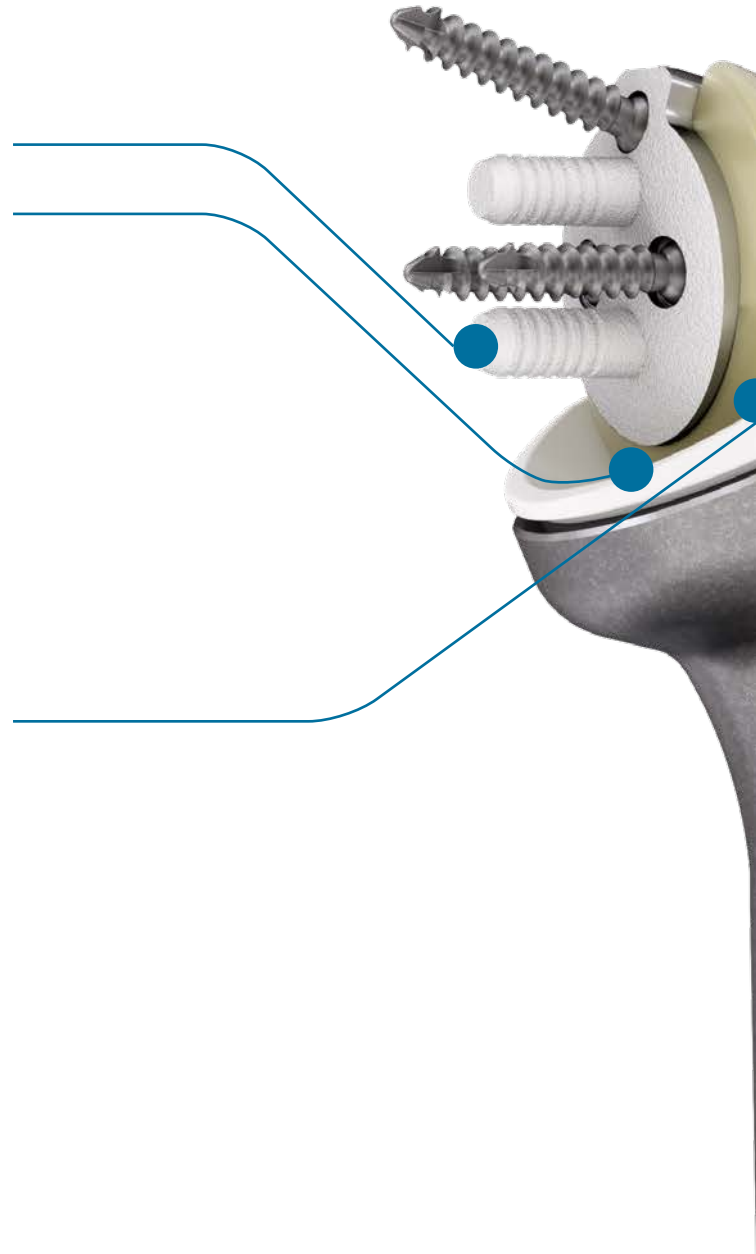



Progressive

In case of possible hypersensitivity to metal ions, Affinis Inverse provides a standard solution for allergy patients. The unique vitamys-ceramic tribological pairing highlights the principle for low wear¹⁵ and durable prostheses.

Clever

A straightforward set concept and a clever instrumentation simplify the workflow during implantation. Furthermore, all surgical steps are instrument guided, thereby reproducible results can be achieved.

Evolutionary, inverse & proven **Affinis Inverse**

AFFINIS SHOULDER SYSTEM

The Affinis Shoulder system covers a wide range of indications: Whether primary treatment, fracture or revision prosthesis – the prostheses solve orthopaedic challenges systematically and uncompromisingly and are defined by a sophisticated implant design as well as by use of advanced materials.



**Affinis
Short**

*Stemless
anatomical*



**Affinis
Classic**

Anatomical



**Affinis
Inverse**

Inverse



**Osteoarthritis
of the shoulder**



**Rotator defect
arthropathy**

«A system for a wide range of indications.»

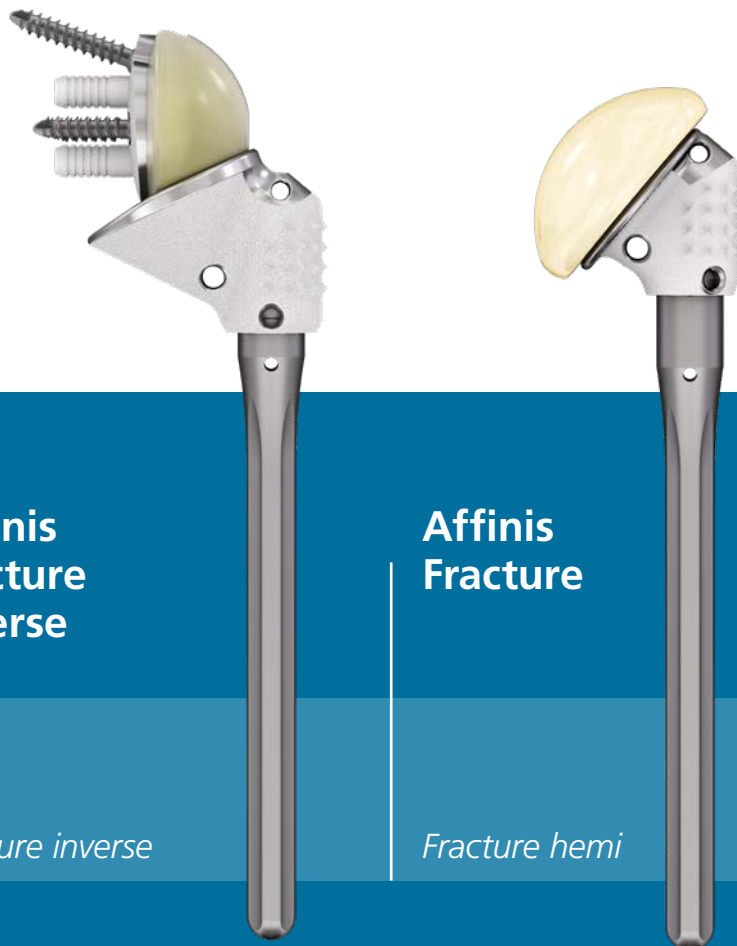

**Affinis
Fracture
Inverse**

**Affinis
Fracture**

Fracture inverse

Fracture hemi



**Proximal humerus
fracture**

REFERENCES

- ¹ Mollon B, Mahure S A, Roche C P, Zuckerman J D. Impact of scapular notching on clinical outcomes after reverse total shoulder arthroplasty: an analysis of 476 shoulders. *J Shoulder Elbow Surg.* 2017;26(7):1253-61.
- ² Mole D, Favard L. [Excentered scapulohumeral osteoarthritis]. *Rev Chir Orthop Reparatrice Appar Mot.* 2007;93(6 Suppl): 37-94.
- ³ ODEP Rating: <http://www.odep.org.uk/products.aspx>, last access 29.10.2020.
- ⁴ Wall B, Nove-Josserand L, O'Connor D P, Edwards T B, Walch G. Reverse total shoulder arthroplasty: a review of results according to etiology. *J Bone Joint Surg Am.* 2007;89(7):1476-85.
- ⁵ National Joint Registry for England, Wales, Northern Ireland and the Isle of Man (NJR). Summary Report SP Humeral Affinis Inverse (Reverse Total) 25-08-20. Data valid to 25 December 2020.
- ⁶ Walter G, Gramlich Y. Periprothetische Infektionen/Infektion-periprothetische. In: *Orthopädie und Unfallchirurgie.* Springer Berlin Heidelberg. ISBN 978-3-642-54673-0. 2019;1-25.
- ⁷ Australian Orthopaedic Association National Joint Replacement Registry (AOANJRR). Hip, Knee & Shoulder Arthroplasty: 2020 Annual Report, Adelaide; AOA, 2020: 1-474. [Accessed from: <https://aoanjrr.sahmri.com/annual-reports-2020>]. Table ST48, page 368.
- ⁸ Kohut G, Dallmann F, Irlenbusch U. Wear-induced loss of mass in reversed total shoulder arthroplasty with conventional and inverted bearing materials. *J Biomech.* 2012;45(3):469-73.
- ⁹ Alexander J J, Bell S N, Coghlan J, Lerf R, Dallmann F. The effect of vitamin E-enhanced cross-linked polyethylene on wear in shoulder arthroplasty-a wear simulator study. *J Shoulder Elbow Surg.* 2019.
- ¹⁰ Boileau P, Moineau G, Morin-Salvo N, Avidor C, Godeneche A, Levigne C, Baba M, Walch G. Metal-backed glenoid implant with polyethylene insert is not a viable long-term therapeutic option. *J Shoulder Elbow Surg.* 2015;24(10):1534-43.
- ¹¹ Harris W H. Wear and periprosthetic osteolysis: the problem. *Clin Orthop Relat Res.* 2001(393):66-70.
- ¹² Huang C H, Lu Y C, Chang T K, Hsiao I L, Su Y C, Yeh S T, Fang H W, Huang C H. In vivo biological response to highly cross-linked and vitamin e-doped polyethylene – a particle-Induced osteolysis animal study. *J Biomed Mater Res B Appl Biomater.* 2016;104(3):561-7.
- ¹³ Willmann G. Improving Bearing Surfaces of Artificial Joints. *Advanced Engineering Materials.* 2001;2(3):135-41.
- ¹⁴ Barnes D H, Moavenian A, Sharma A, Best S M. Biocompatibility of Ceramics. *ASM Handbook.* 2012;23.
- ¹⁵ Lerf R, Wuttke V, Reimelt I, Dallmann F, Delfosse D. Tribological Behaviour of the «Reverse» Inverse Shoulder Prosthesis. 7th International UHMWPE Meeting. Philadelphia 2015.
- ¹⁶ de Wilde L F, Poncet D, Middernacht B, Ekelund A. Prosthetic overhang is the most effective way to prevent scapular conflict in a reverse total shoulder prosthesis. *Acta Orthop.* 2010;81(6):719-26.
- ¹⁷ Irlenbusch U, Kaab M, Kohut G, Proust J, Reuther F, Joudet T. Reversed shoulder arthroplasty with inversed bearing materials: 2-year clinical and radiographic results in 101 patients. *Arch Orthop Trauma Surg.* 2015;135(2):161-9.

Preservation in motion

